

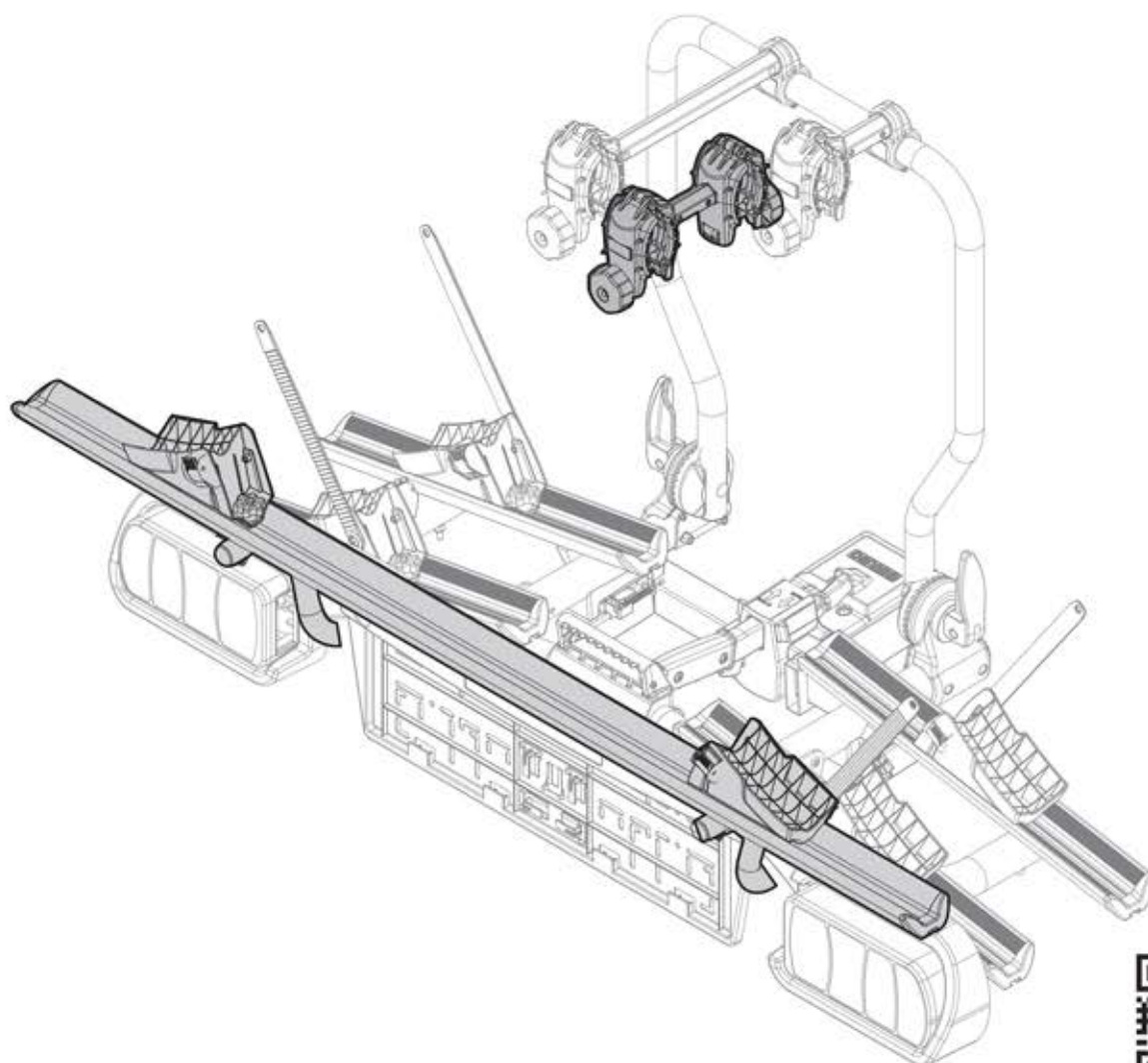



















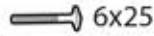











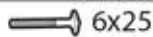



# ALPHARD KIT+1

<b>IT</b>	Istruzioni di montaggio	<b>LV</b>	Pritvirtinimo instrukcijas
<b>EN</b>	Fitting instructions	<b>NL</b>	Instrukcja montażu
<b>DE</b>	Montageanleitung	<b>NO</b>	Monteringsveiledning
<b>FR</b>	Instructions de montage	<b>PL</b>	Instrukcja montażu
<b>ES</b>	Instrucciones de montaje	<b>PT</b>	Instruções de Montagem
<b>CZ</b>	Návod na montáž	<b>RO</b>	Instrucțiuni de montare
<b>DA</b>	Monteringsvejledning	<b>RU</b>	Инструкции по установке
<b>EL</b>	Οδηγίες συναρμολόγησης	<b>SK</b>	Návod na montáž
<b>ET</b>	Paigaldusjuhend	<b>SL</b>	Navodila za pritrjevanje
<b>FI</b>	Asennusohje	<b>SV</b>	Monteringsanvisning
<b>HR</b>	Uputa za sastavljanje	<b>TK</b>	Uydurma talimat
<b>HU</b>	A felszerelés módja	<b>ZH</b>	裝修指導
<b>LT</b>	Stiprināšanas instrukcija	<b>AR</b>	تعليمات التجميع





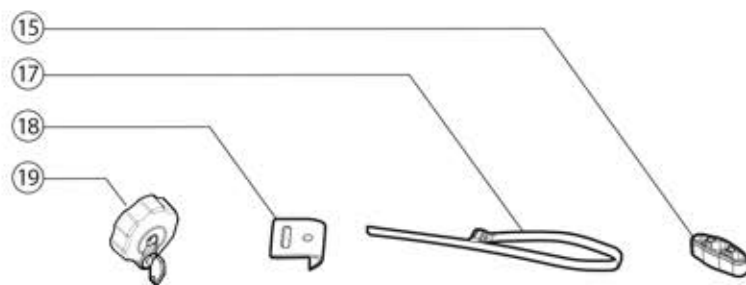
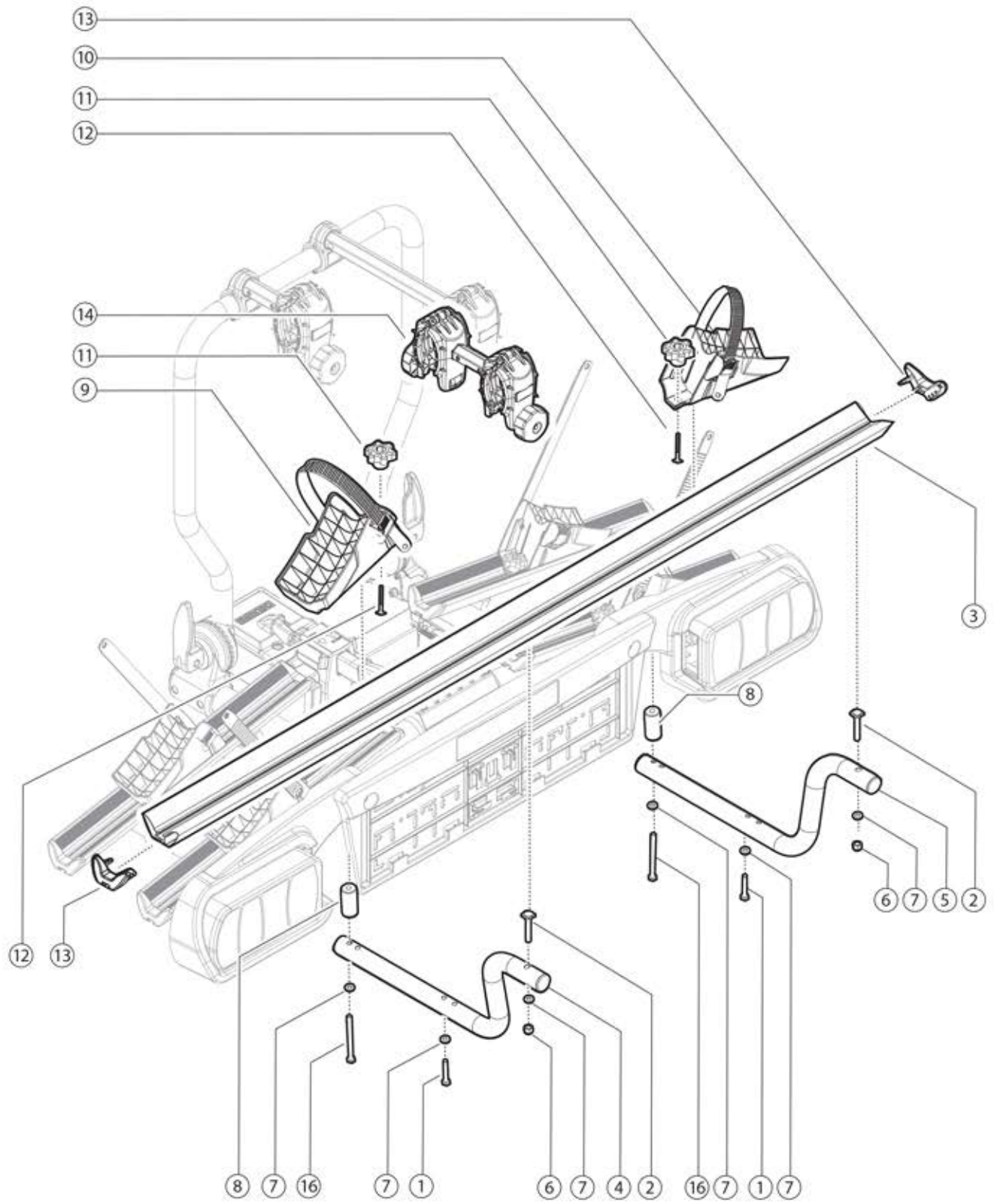

N	<ul style="list-style-type: none"> <li>■ Componenti (Inclusi)</li> <li>■ Components (Included)</li> <li>■ Composants (Comprises)</li> <li>■ Die Komponenten (im Lieferumfang enthalten)</li> <li>■ Componentes (Incluido)</li> <li>■ Компоненты (в комплекте)</li> </ul>	Q
1	 M6x35	2
2	 M6x35	2
3		1
4	 sx	1
5	 dx	1
6	 M6	2
7	 M6	6
8		2
9	 sx	1
10	 dx	1
11		2
12	 6x25	2
13		2
14		1
15		1
16	 M6x70	2
17	 2,5mt - 8,2 ft	1
18		1
19		2

N	<ul style="list-style-type: none"> <li>■ Ricambi (A Richiesta)</li> <li>■ Spare Parts (Made to order)</li> <li>■ Pièces de rechange (Sur commande)</li> <li>■ Teile (auf Anfrage)</li> <li>■ Piezas de recambio (Previa solicitud)</li> <li>■ Запасные части (по запросу)</li> </ul>	Q	Codice - Code Código - код
1	 M6x35	2	700023500000
2	 M6x35	2	
6	 M6	2	
7	 M6	6	
12	 6x25	2	
16	 M6x70	2	
8		1	700023600000
9	 sx	1	700017400000
10	 dx	1	
11		1	700001300000
12	 6x25	1	
13		2	700015500000
14		1	700006900000
15		1	700017500000
17	 2,5mt - 8,2 ft	1	700001100000
18		1	700004700000
19		1	000026400000



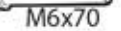

1

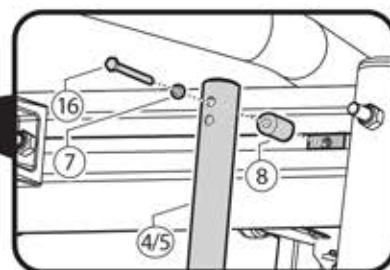
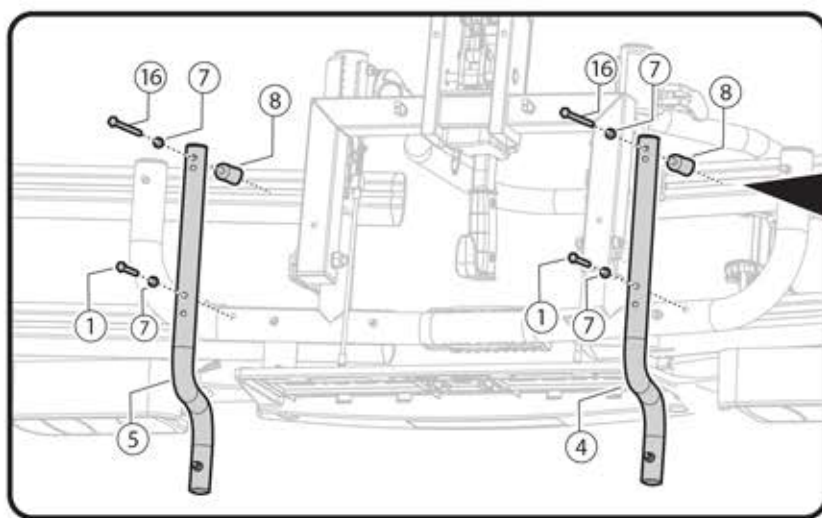
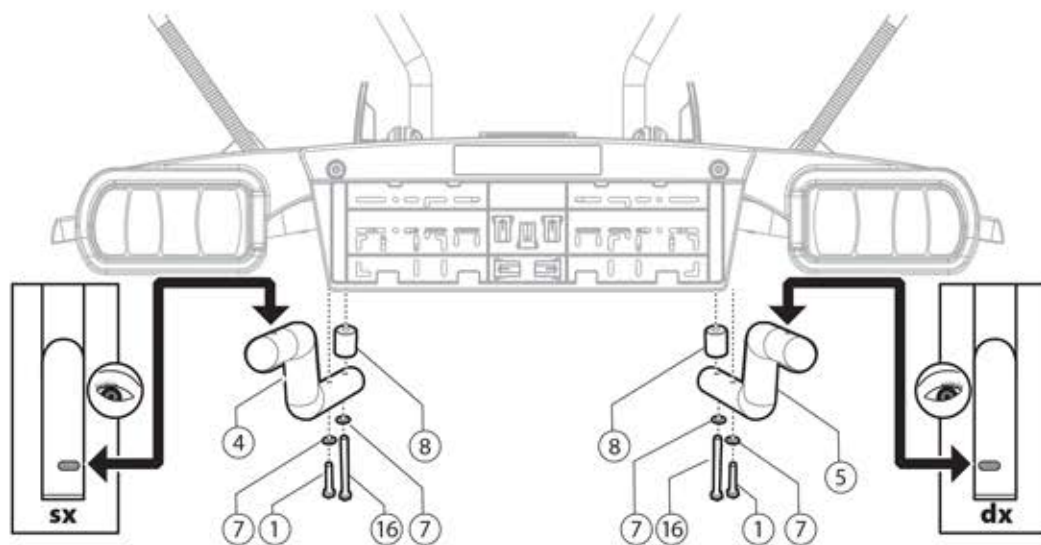
N		Q
1	 M6x35	2
4	 SX	1
5	 dx	1
7	 M6	4
8		2
16	 M6x70	2



2

N		Q
2	 M6x35	2
3		1
6	 M6	2
7	 M6	2

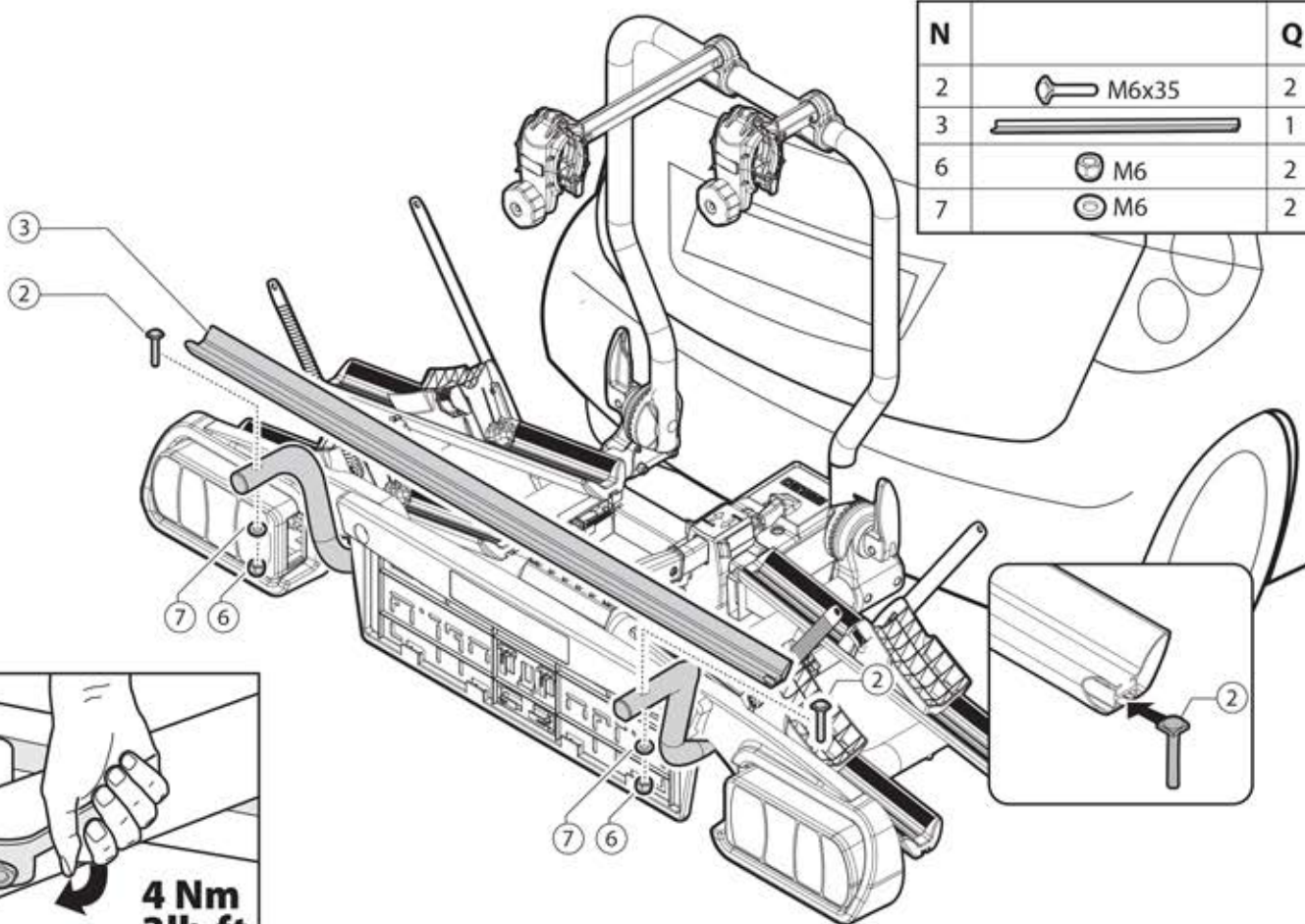

3

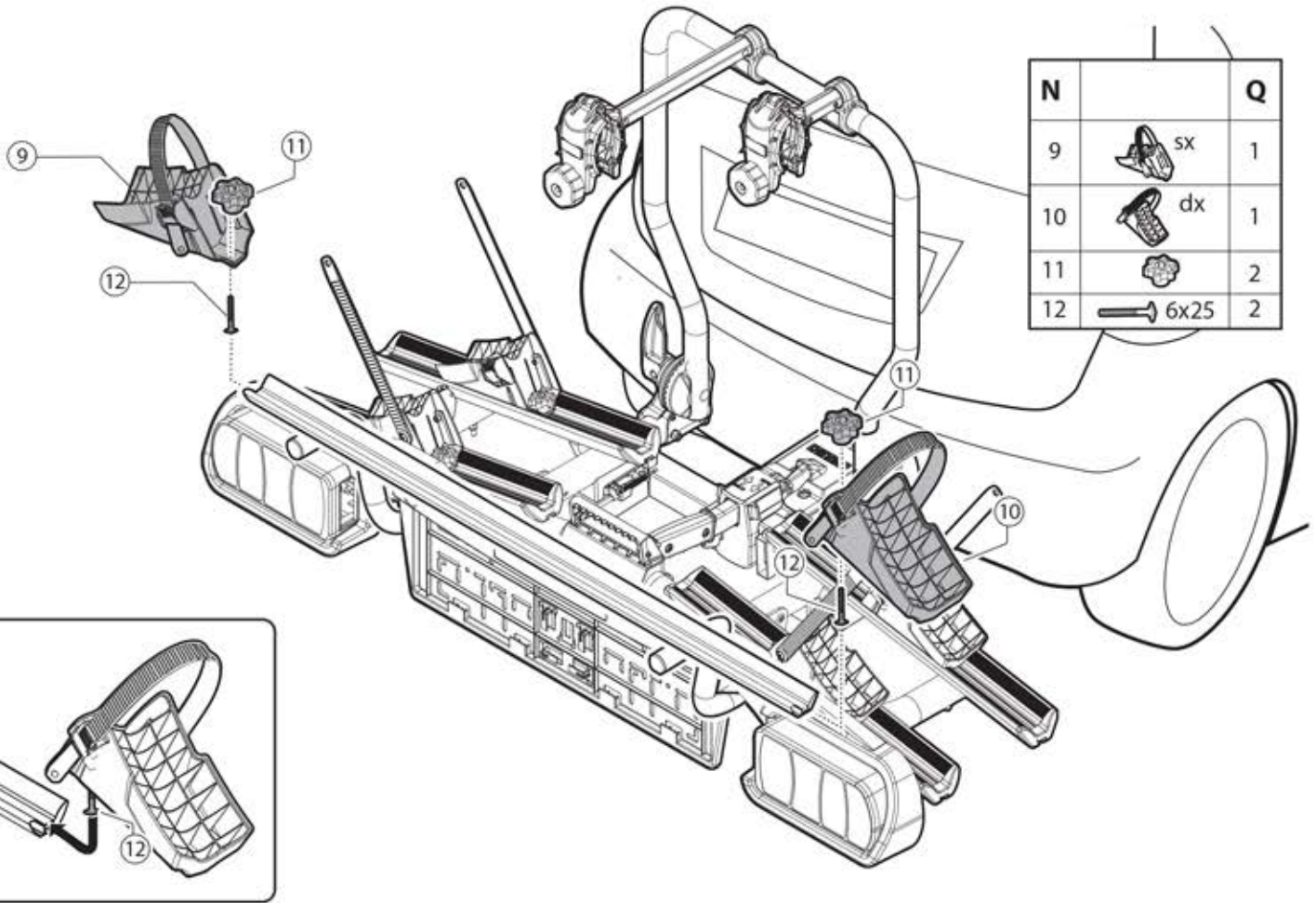

N		Q
9	SX	1
10	dx	1
11		2
12	6x25	2

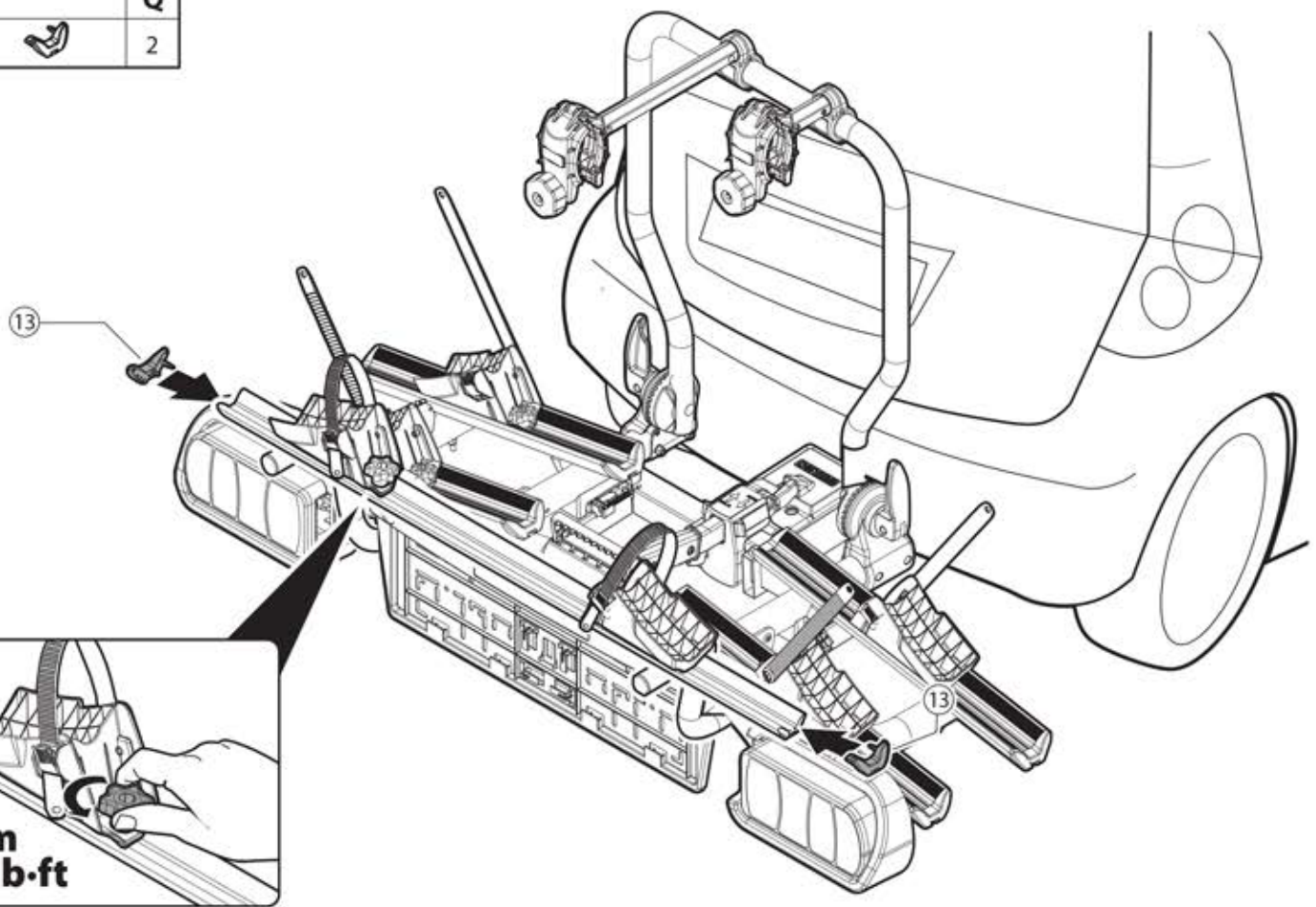

4

N		Q
13		2





**2 Nm**  
**1,5 lb·ft**

**5**

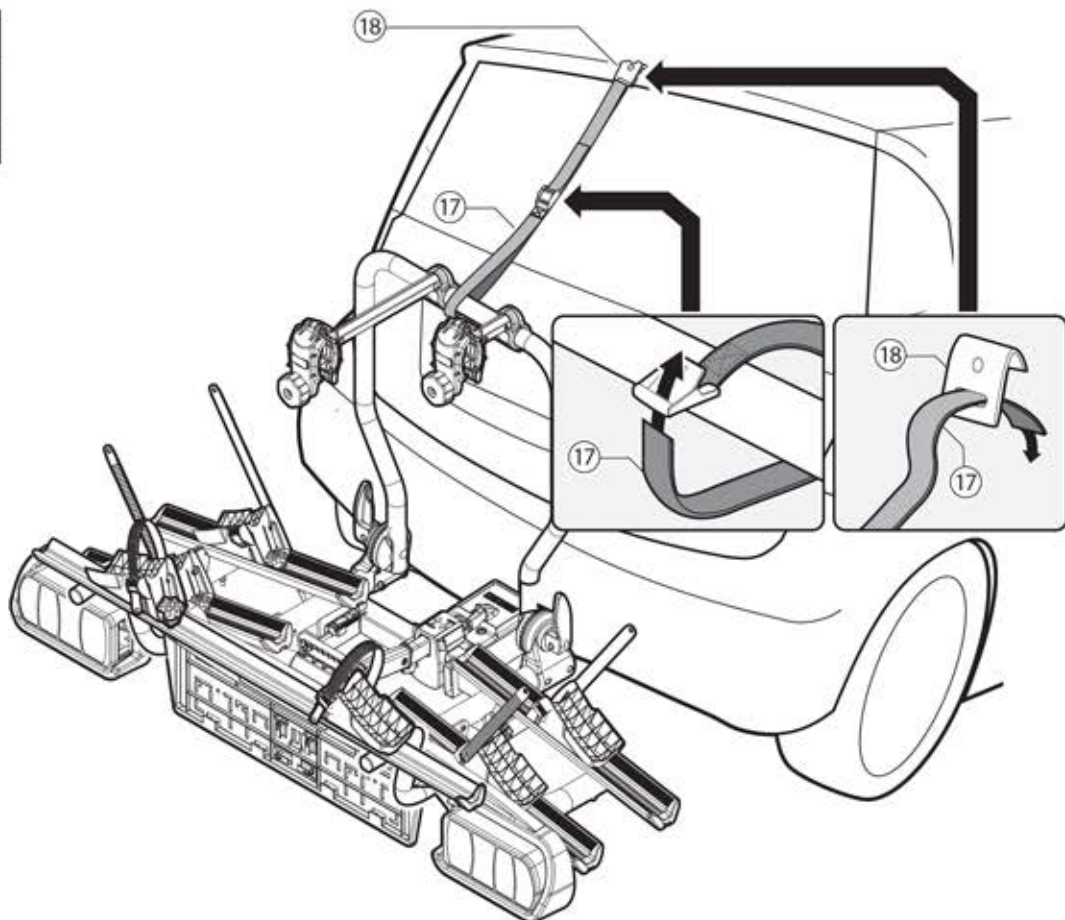
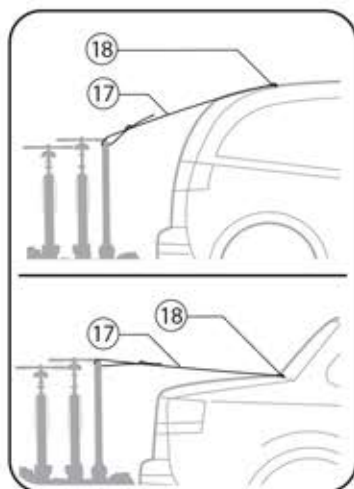
N		Q
17	 2,5mt - 8,2 ft	1
18		1

**6**

N		Q
14		1
19		2

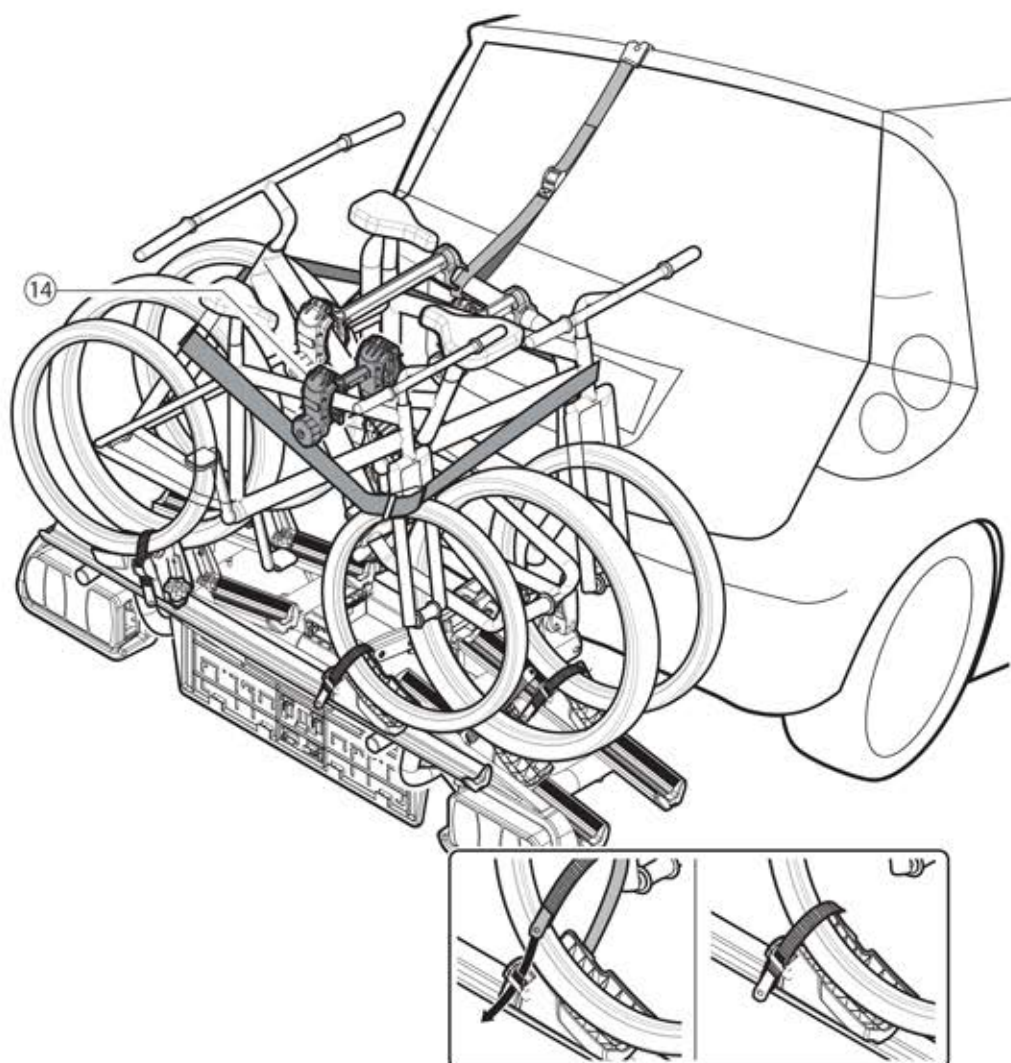
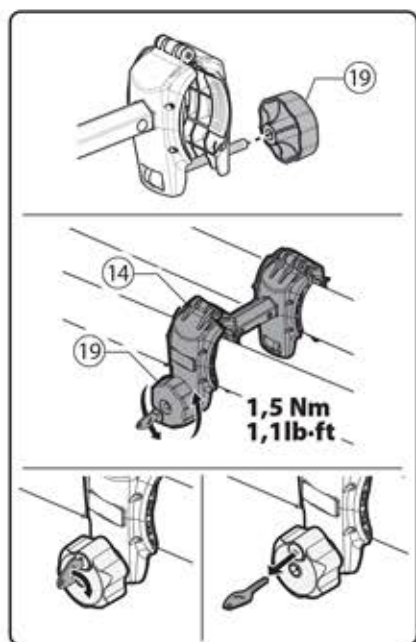

	<p>● MIN Ø30mm / 1,2" ● MAX Ø50mm / 2"</p> <p>● MIN 30x60mm / 1,2"x 2,3" ● MAX 50x70mm / 2"x 2,7"</p>		<p>MIN 22" MAX 29"</p>		<p>MAX 75mm / 3"</p>		<p>MAX 125cm / 59,8"</p>
---	---	---	----------------------------	---	----------------------	---	--------------------------







40 cm 15,7"

 **No Tandem**



















**TILTING SYSTEM**

**130**  
km/h

**80**  
mph







 SPEED



 SPEED



<p><b>MAX</b></p>  <p>94/20/CE STANDARD</p>			 x3	<p>Car Manual</p> 
	16,2 kg - 35,7 lbs	2,7 kg - 6 lbs	<b>MAX 15kg - 33 lbs</b>	
	50 kg - 110,2 lbs	18,9 kg - 41,6 lbs	MAX 31,1 kg - 68,6 lbs	
	60 kg - 132,2 lbs		MAX 41,1 kg - 90,6 lbs	
	70 kg - 154,3 lbs		MAX 45 kg - 99,2 lbs	
>70 kg - 154,3 lbs	MAX 45 kg - 99,2 lbs			

Cod. Istr.	Data	Creato da	Approvato da
500005800000	09/01/2018	NP	EL

F.lli Menabò S.r.l.  
Via 8 Marzo, 3  
I - 42025 Cavriago (RE)  
Tel. +39-0522/942840  
Fax. +39-0522/942948  
e-mail: [info@flli-menabo.it](mailto:info@flli-menabo.it)  
Web-site: [www.flli-menabo.it](http://www.flli-menabo.it)